

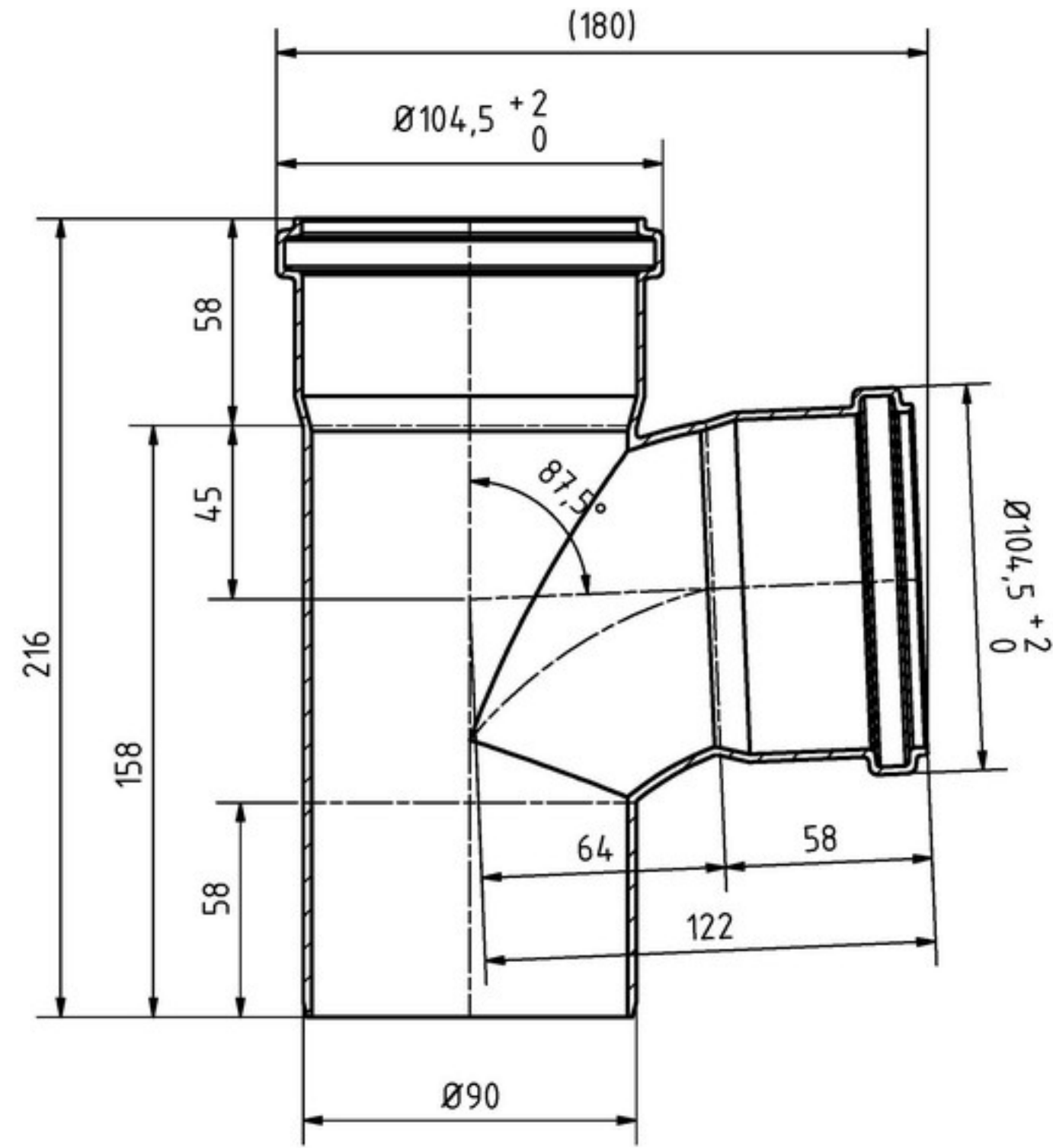

A-A ( 1 : 2 )

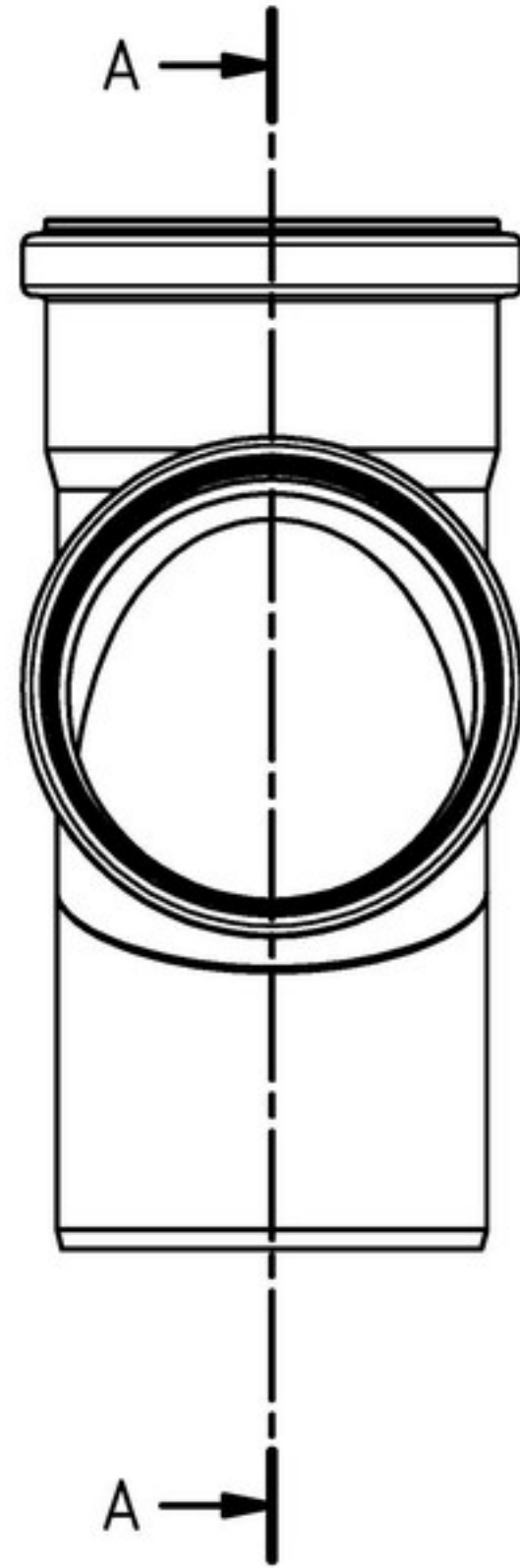

		Maße nach DIN EN 1451-1		Art.Nr.: 174400		Maßstab 1:2	
				Material: PP-H schwerentflammbar			
		Datum		Name		<h1>HT Safe</h1>	
		Gezeichnet: 30.09.2016		A.Schmedes			
		Kontroll.					
Status	Änderungen	Datum	Name	Norm			
						HTsafeEA Abzweig DN/OD 90/90/87°	
						<span style="font-size: 2em;">1</span> A3	
Schutzvermerk nach DIN ISO 16016 beachten!							