

ANTIK Wand-Amphore  
 Amphore antique murale  
 Antique wall amphore  
 Ánfora de pared ANTIK  
 Anfora da parete anticata

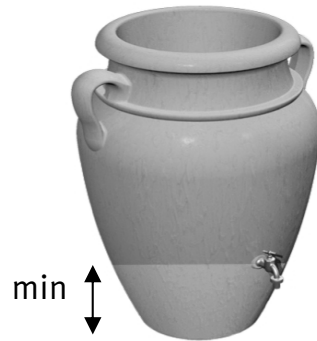

ANTIK Amphore  
 Amphore antique  
 Antique amphore  
 Ánfora ANTIK  
 Anfora anticata

**Aufstellanleitung**  
**Notice de montage**  
**Installation manual**  
**Instrucciones de montaje**  
**Istruzioni per l'installazione**



600 L

360 L

200 L

260 L

ANTIK Amphore  
 Amphore antique  
 Antique amphore  
 Ánfora ANTIK  
 Anfora anticata

ANTIK Wand-Amphore  
 Amphore antique murale  
 Antique wall amphore  
 Ánfora de pared ANTIK  
 Anfora da parete anticata

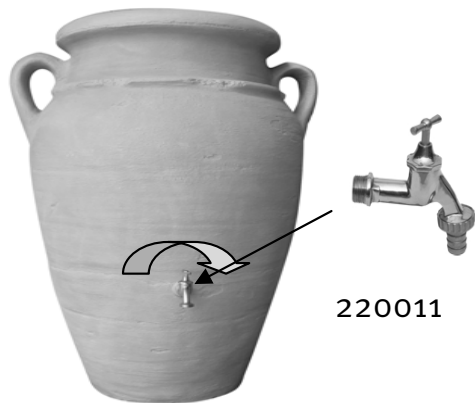
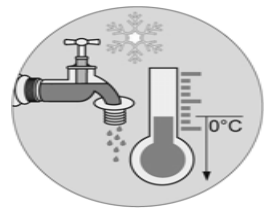

220011

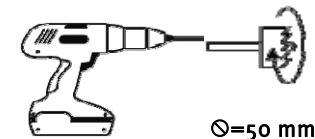

1.

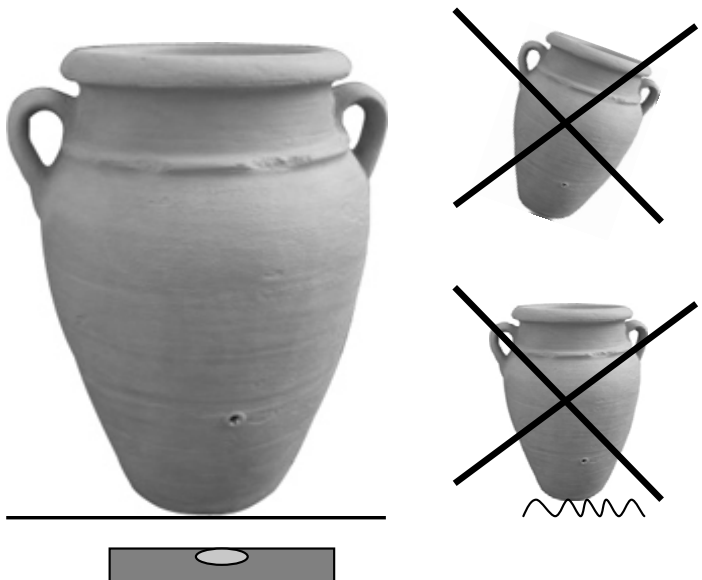

2.

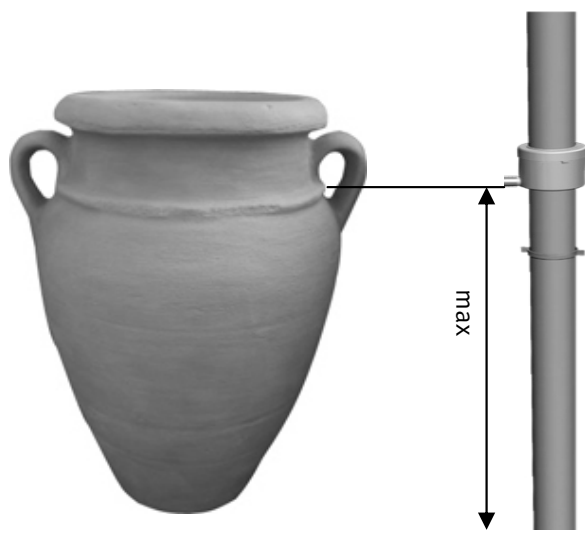

3.



4.

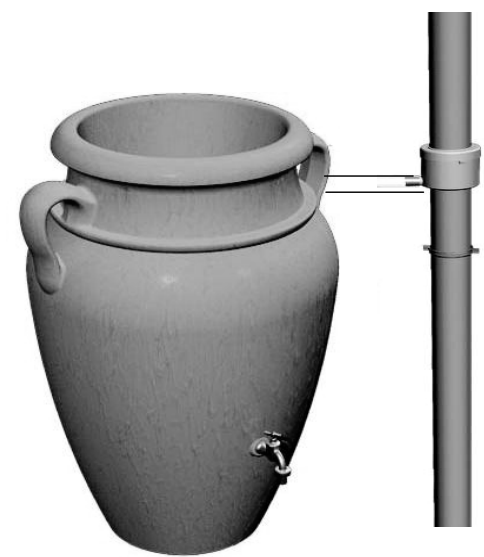



**Superplastic S.A. | Quai Timmermans 44 - 4000 LIEGE**  
**Tél: +32(0)4 252 98 70 - Fax: +32(0)4 252 30 64 | [www.superplastic.be](http://www.superplastic.be)**